

**382STM8HDWL**  
**8' WINGED HEADWALL**

Size	8'
Max. CMP	42"
Max. RCP	36"
WT./#	5625
WT./# W/Toe	6175

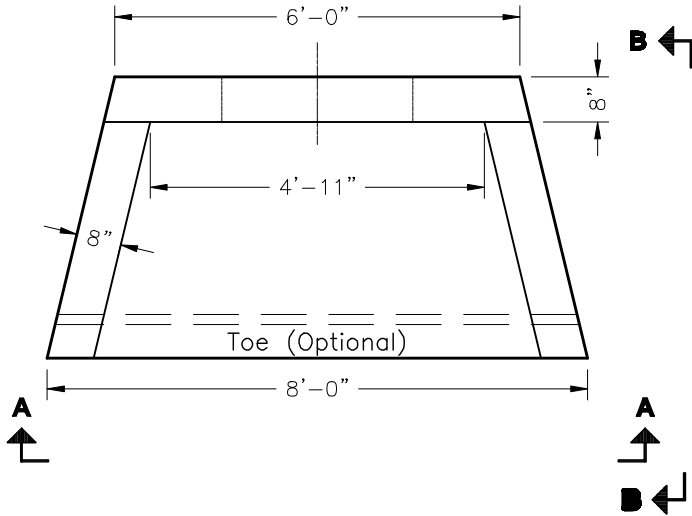

**PLAN VIEW**

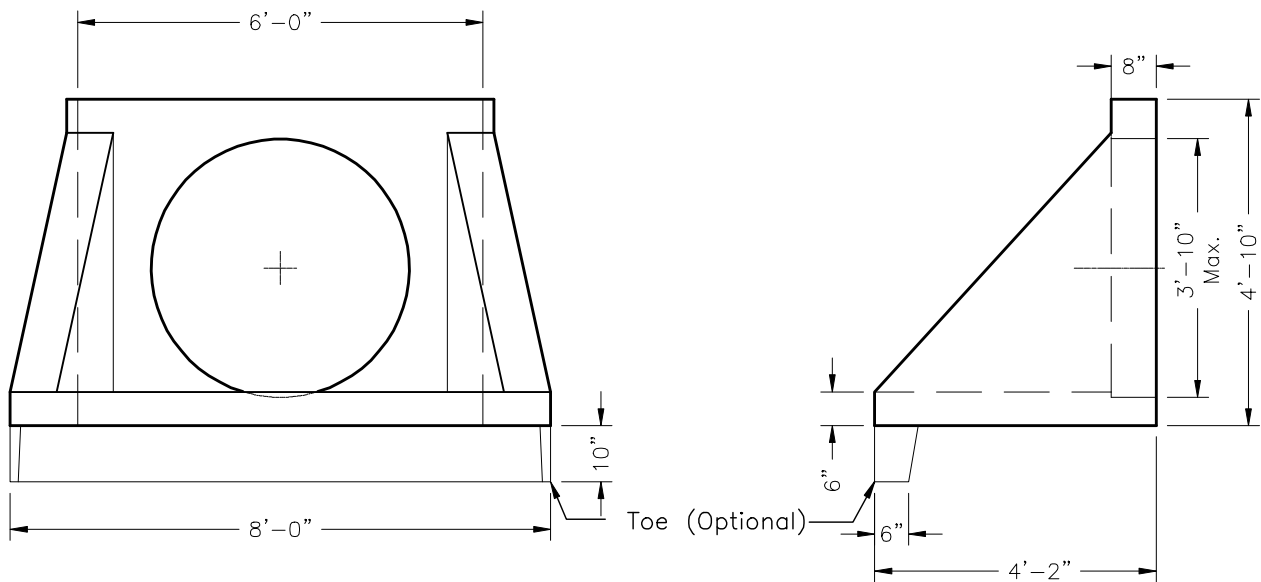

**ELEVATION A-A**

**ELEVATION B-B**

**Scale: 3/8"=1'-0"**