

382STMDPE4B36
D-PE-4B State Endwall for 36

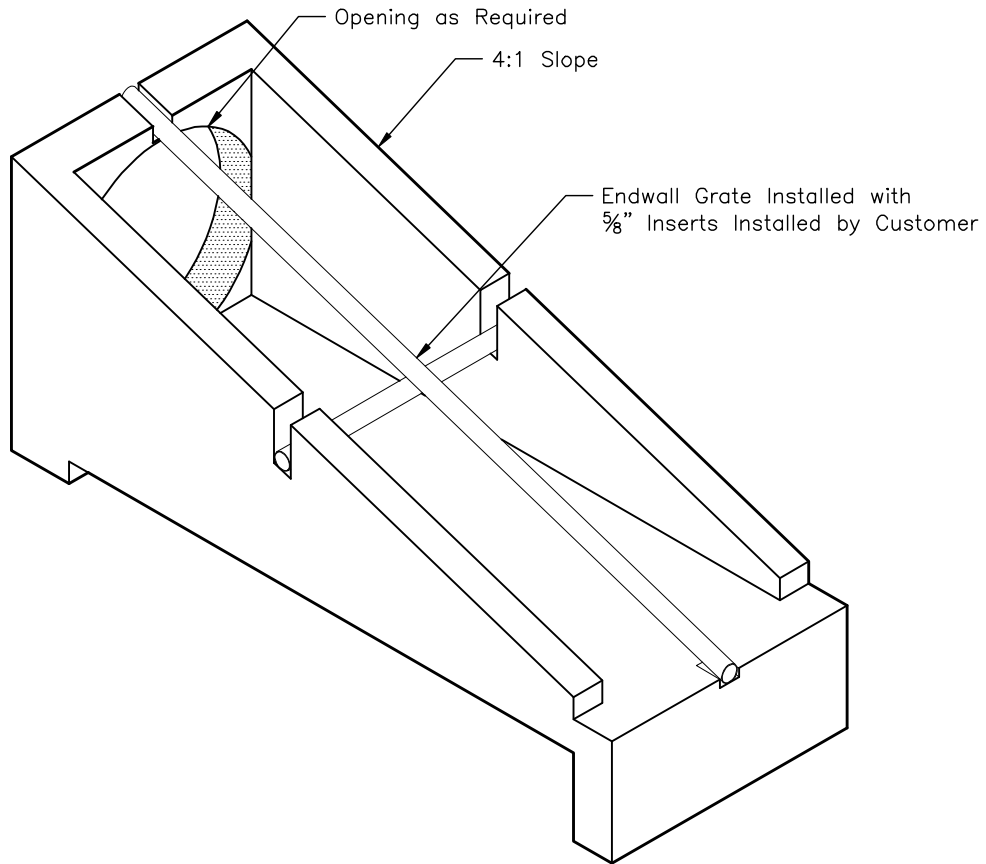

www.oldcastle-precast.com
5900 East Division Street
Lebanon, Tennessee 37090

Phone (615) 453-6111
Fax (615) 453-6080

**ITEMS ARE SUBJECT TO CHANGE WITHOUT NOTICE.
FOR DETAILS SEE REVERSE SIDE.**