

NOTES:

1. Concrete: 5,000 P.S.I
Minimum Strength @ 28 Days
2. Steel Reinforcing- ASTM A-615,
Grade 60.
3. Cover to Steel-1" Minimum
4. Vault are Designed to Meet ASTM
C858 and ACI 318 with AASHTO
HS-20 Loading
5. Construction Joint-Sealed with
1"Dia Butyl Rubber or Equivalent
6. Approx. Wt. Top Pc. = 11.6 Tons
Approx. Wt. Bottom Pc. = 11.6 Tons

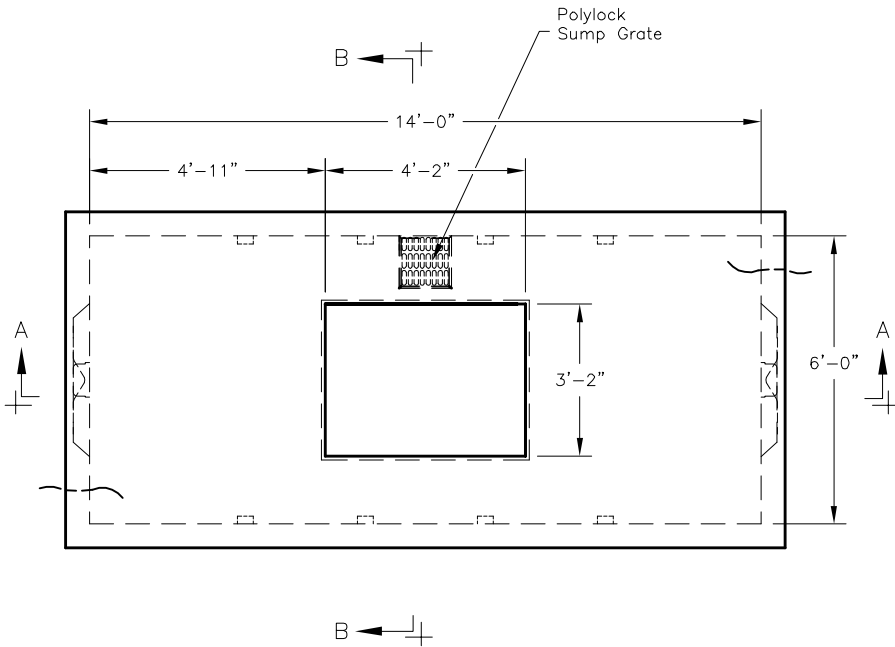

PLAN VIEW

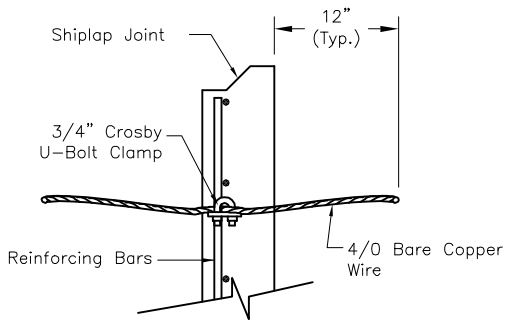

DETAIL "A"

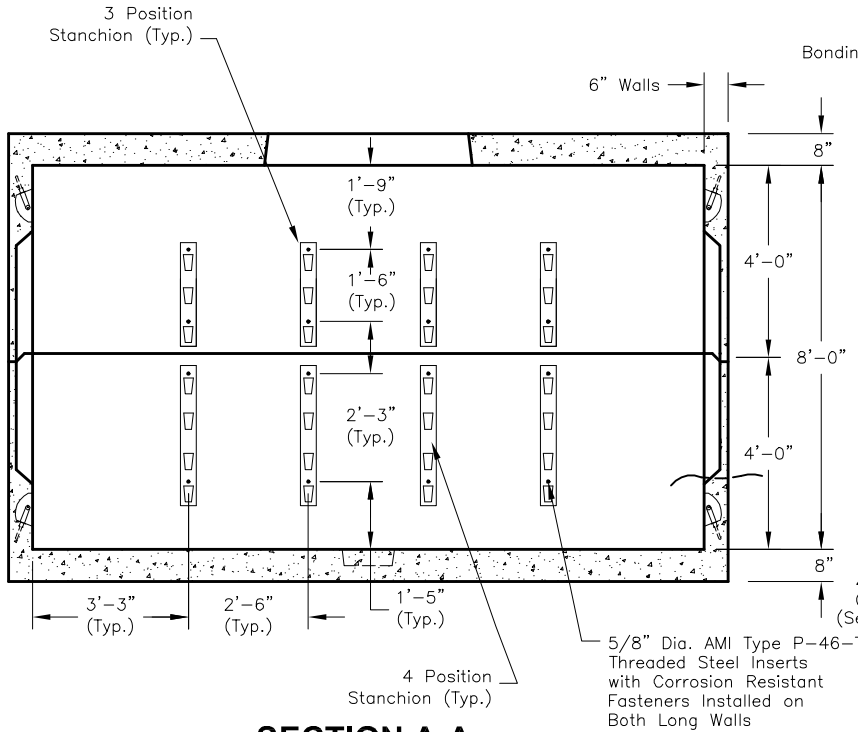

SECTION A-A

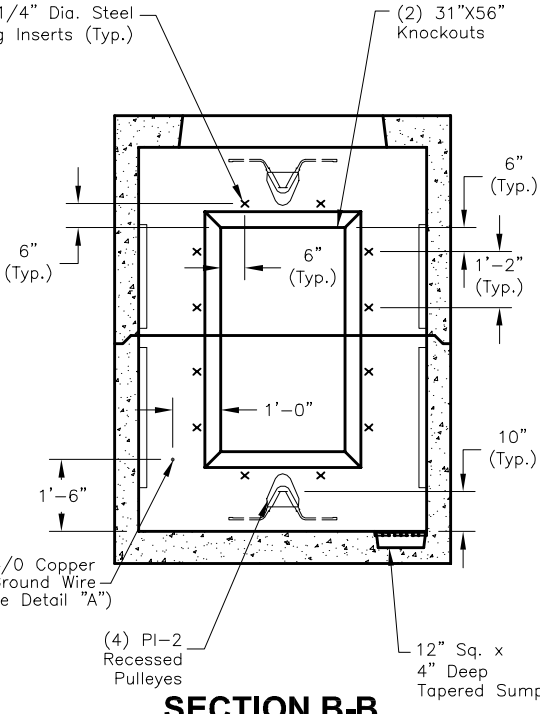

SECTION B-B



NS6X14X8

FILE NAME:324UEENS6X14X8_DET.DWG

ISSUE DATE: January, 2008

www.oldcastleprecast.com

**6'-0" x 14'-0" x 8'-0" I.D.
NSTAR Utility Vault
M1213 - Cat. # 16244**

Copyright © 2008 Oldcastle Precast