

**Ring and Cover**

As Specified

**Grade Rings**

27" Keyed or Blunt

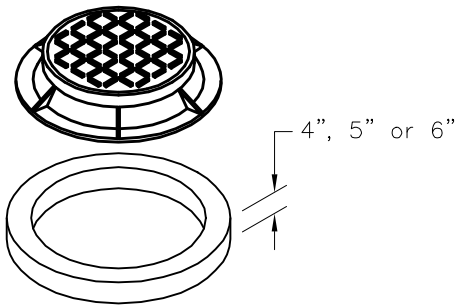

**Concentric Cone**

Height=3'-0"

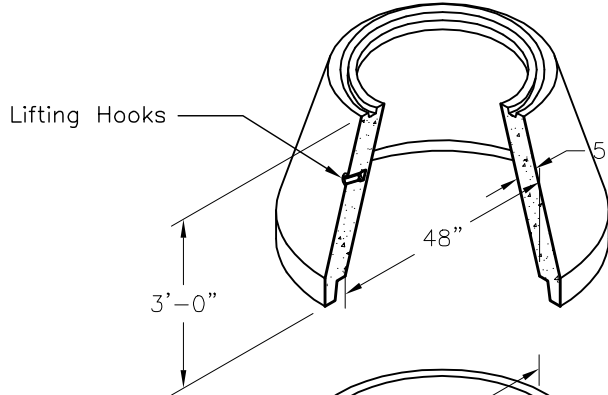

**Riser Section**

Standard Height:  
1'-4" Multiples

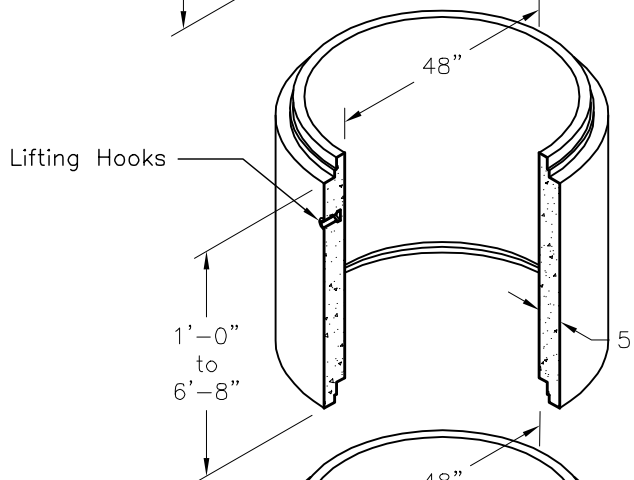

**Base Riser  
w/Integral Base Slab**

Field Cast Invert

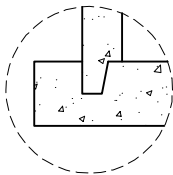
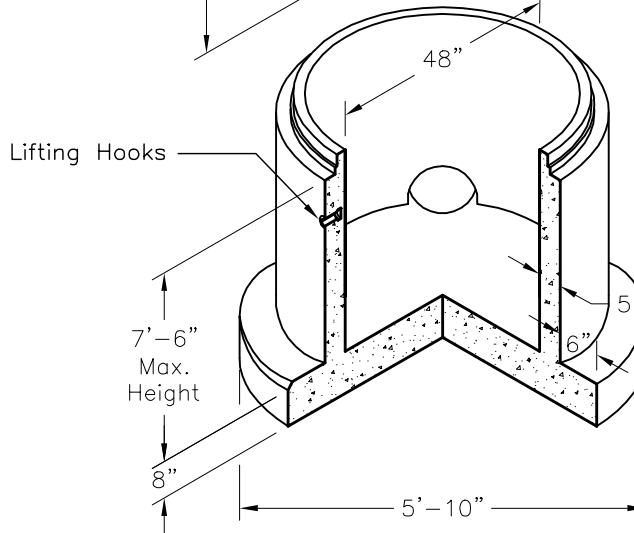

**Alternate Design  
Manufactures Option**



5230 N.W. 17th Street, Topeka, KS 66618  
Phone: 785.232.2982 Fax: 785.232.5842

**48MHCC36**

FILE NAME: 120DMM48MHCC36\_ISO

ISSUE DATE: January 2007

[www.vanguardprecast.com](http://www.vanguardprecast.com)

**Standard 48" ID Manhole  
3'-0" Concentric Cone**

Copyright © 2007 Oldcastle Precast