

Ring and Cover

As Specified

Grade Rings

27" Keyed or Blunt

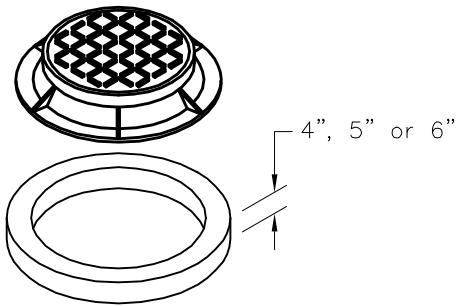

Concentric Cone

Height=4'-0"

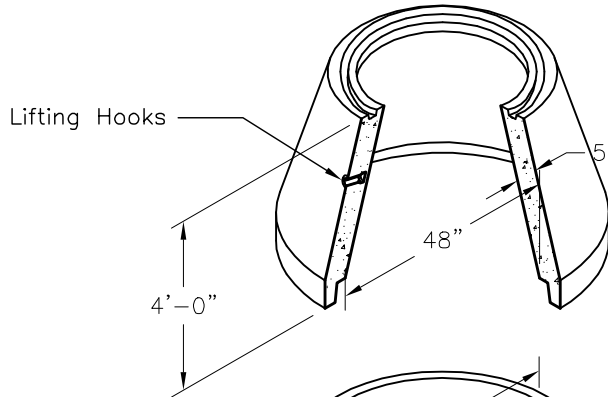

Riser Section

Standard Height:
1'-4" Multiples

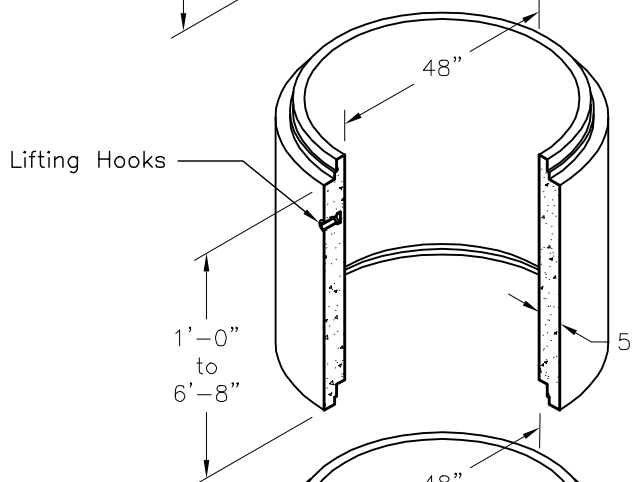

**Base Riser
w/Integral Base Slab**

Field Cast Invert

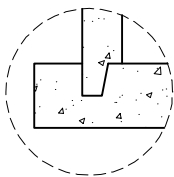
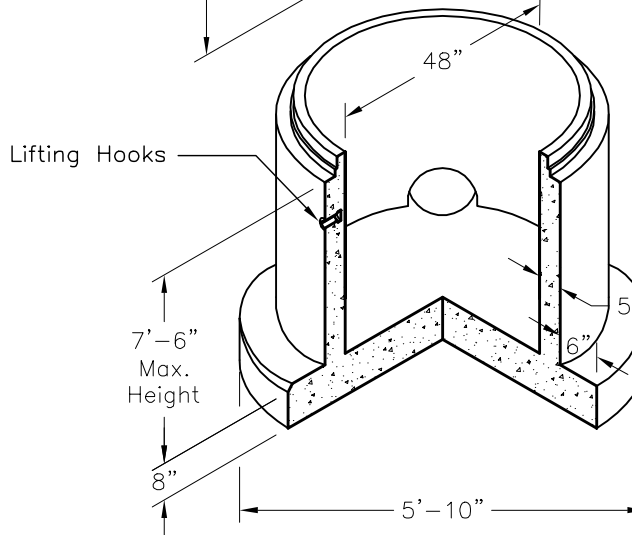

**Alternate Design
Manufactures Option**



5230 N.W. 17th Street, Topeka, KS 66618
Phone: 785.232.2982 Fax: 785.232.5842

48MHCC48

FILE NAME: 120DMM48MHCC48_ISO

ISSUE DATE: January 2007

www.vanguardprecast.com

**Standard 48" ID Manhole
4'-0" Concentric Cone**

Copyright © 2007 Oldcastle Precast